

IMPORTANT

Flex Mount Pods are only compatible with marine electronics devices as stated in the latest Scanstrut Product Guide – subject to change without prior notice.

Use with unapproved products, or overloading, invalidates any warranty.

No liability is accepted for damage caused by incorrect installation.

The installation and assembly must be regularly inspected for evidence of damage or loose parts.

This product has been designed specifically for the mounting of approved marine electronics devices under normal boating conditions.

This product is designed to be fitted to pedestal guards manufactured from stainless steel tubing, Ø25-33.7mm [1" - 1.33"] with wall thicknesses of 1.5mm[1/16"] minimum.

For installations that differ from those stated here, please consult Scanstrut head office.

IMPORTANT

Les Boîtiers de Barre à roue sont uniquement compatibles avec les appareils d'électronique marine repris dans le dernier Guide Produits Scanstrut – sujet à Modification sans préavis.

L'usage des avec des produits non validés, ou la surcharge, annulent toute garantie.

Scanstrut décline toute responsabilité pour les dégats résultant d'une installation incorrecte.

L'installation et l'assemblage doivent être inspectés régulièrement afin de déceler des dégats ou des pièces desserrées.

Ce produit a été spécifiquement conçu pour le montage d'appareils d'électronique marine approuvés dans des conditions de navigation normales.

Ce produit est conçu pour un montage sur pied ou chandelier en tube inox de Ø25mm et 33.7mm [1" et 1.33"], d'une épaisseur de 1.5mm[1/16"] minimum.

Pour les installations différentes de celles reprises ici, veuillez contacter le siège social de Scanstrut.

WICHTIG

Steuerhalterungen sind nur mit Elektronikgeräten für die Schifffahrt kompatibel, wie in der aktuellen Scanstrut Produktübersicht erwähnt. Änderungen ohne vorherige Ankündigung vorbehalten.

Durch die Verwendung mit nicht genehmigten Produkten bzw. durch Überlastung wird jegliche Garantie ungültig.

Für Schäden aufgrund unsachgemäßen Einbaus wird keine Haftung übernommen.

Der Anbau und die Baueinheit müssen regelmäßig auf Anzeichen von Schäden oder lockere Teile geprüft werden.

Dieses Produkt wurde spezifisch für die Befestigung genehmigter Elektronikgeräte für die Schifffahrt unter normalen Bootsfahrtsbedingungen entwickelt.

Dieses Produkt ist für die Montage an einem Säulenschutz aus Edelstahlrohr, Ø25 -33.7 mm [1" - 1,33"] mit einer Wandstärke von mindestens 1,5 mm [1/16"].

Für andere Anbauten als die hier genannten wenden Sie sich bitte an die Scanstrut Zentrale.

IMPORTANTE

Gli Flex Mount Pods sono compatibili solo con apparecchiature elettroniche navali come indicato nella più recente Guida ai Prodotti Scanstrut – fatte salve eventuali modifiche senza preavviso.

L'utilizzo con prodotti non approvati, o un sovraccarico, invalida qualsiasi garanzia.

Si declina qualsiasi responsabilità per danni causati da un'installazione erronea.

L'installazione e il montaggio devono essere ispezionati con regolarità per verificare la presenza di danni o di pezzi allentati.

Questo prodotto è stato studiato appositamente per il supporto di apparecchiature elettroniche navali approvate in normali condizioni di navigazione.

Questo prodotto è stato studiato per essere montato sopra protezioni su piedistallo costruite in tubo di acciaio inossidabile di diam. 25-33.7 mm, con pareti di 1,5 mm.

Per installazioni diverse da quelle qui indicate, si prega di consultare la direzione centrale di Scanstrut.

IMPORTANTE

Flex Mount Pods son compatibles únicamente con equipos electrónicos marinos según se establece en la última Guía de Productos Scanstrut– sujeto a cambios sin previo aviso.

El uso con productos no aprobados, o bajo exceso de carga, invalidará cualquier garantía.

No se aceptará ninguna responsabilidad por los daños causados por una instalación incorrecta.

La instalación y ensamblaje deberá inspeccionarse regularmente, comprobando cualquier evidencia de daños o piezas aflojadas.

Este producto ha sido específicamente diseñado para el montaje de equipos electrónicos marinos aprobados bajo condiciones normales de navegación.

Este producto está diseñado para encajar en guardas de pesetal fabricadas en tubos de acero inoxidable, Ø25-33.7mm [1" - 1.33"] con un grosor de la pared de un mínimo de 1.5mm [1/16"].

Para instalaciones distintas a las establecidas aquí, consulte siempre a su distribuidor Scanstrut.





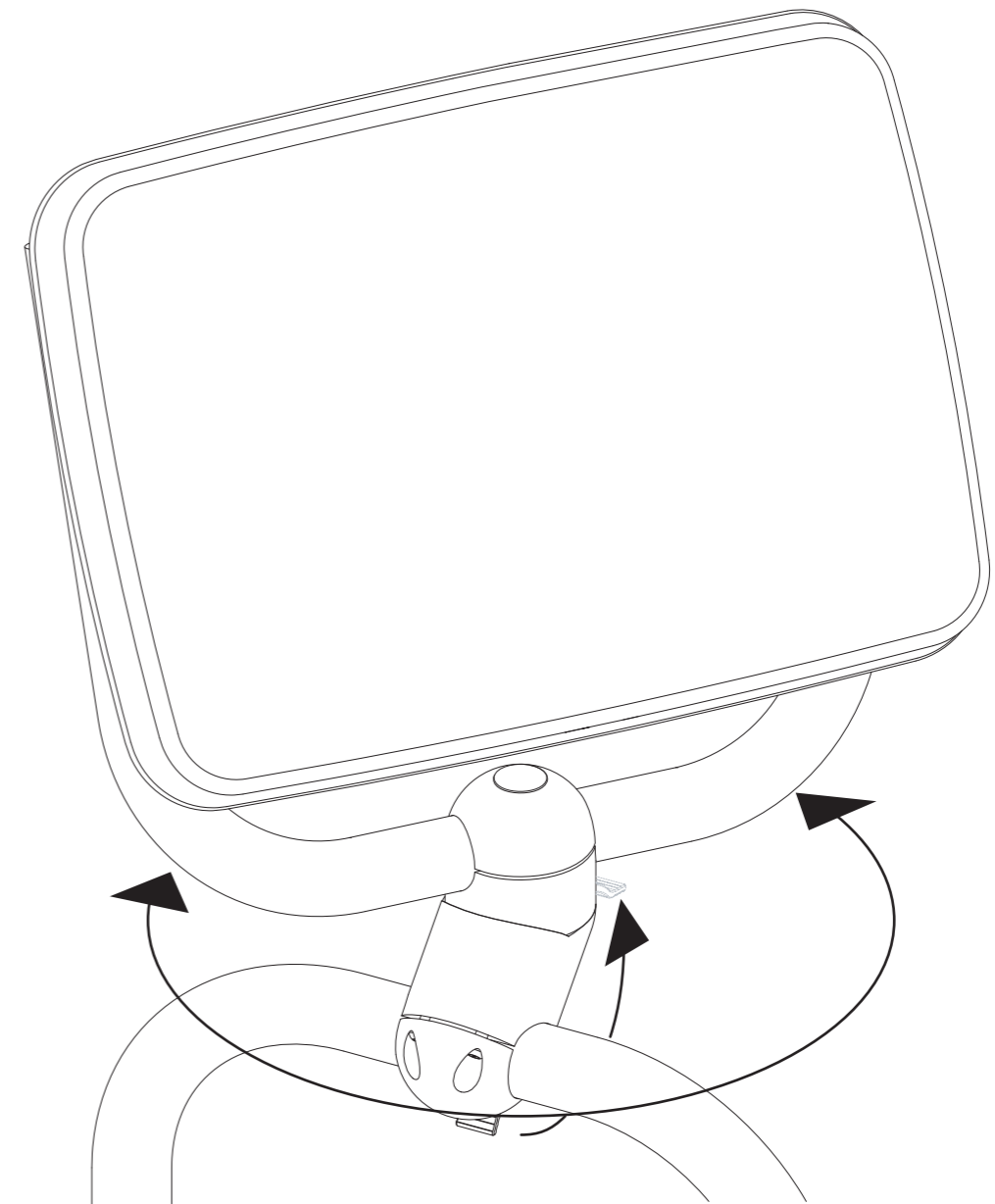

Scanstrut Scanpod Installation Instructions

FLEX MOUNT POD FM-1 & FM-2

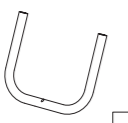



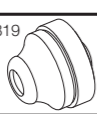
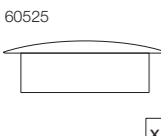
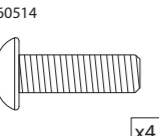



Scanstrut Scanpod Installation Instructions FLEX Mount FM-1 & FM-2



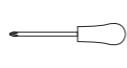







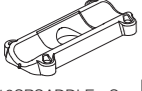

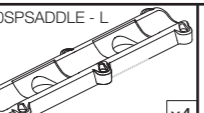
Parts List - Flex Mount Accessory

60085  x1	17SPF-RAIL-8 or -11  x1	101817  x2	Main Body Clamp  x1
60080  x1		101819  x1	
60525  x1	60514  x4	Adapter  x1	Bottom Clamp  x1

Tools Required

	Power drill		Jigsaw/Spiral Saw
	Hole Saw ø16mm (5/8"), ø24mm (15/16")		Posidrive No. 3 Screwdriver
	ø9.5mm drill		3mm Allen Key
	13mm Socket Wrench		

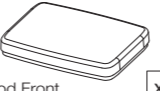
Parts List - Helm POD

SPH-8, 9, 3i, 4i, 4xi		SPH-12, 13		Pod Back	60548/ 60541*
10SPSADDLE - S  x2	190SPH3  x2	4 x 60453  x4	10SPSADDLE - L  x4	190SPH3  x4	60453  x6
60452  x8	190SPH4  x2	60547  x8	12 x 60452  x4	190SPH4  x4	12 x 60547  x12
			Pod Front  x1		60549  x8

60548 - SPH-3i, 4i, 4xi
60541 - SPH-9, 12, 13

